



POLI

MP400 Series
Quick Start Guide



mPower Electronics Inc.
3046 Scott Blvd. Santa Clara, CA 95054
Phone: +1(408)320-1266
Fax: +1(669)342-7077
info@mpowerinc.com
www.mpowerinc.com

PN: M004-4007-000

v1.3

WARNINGS

Read Before Operating

The full POLI User's Guide must be carefully read by all individuals who have or will have the responsibility of using, maintaining or servicing this product. The product will perform as designed only if it is used, maintained and serviced in accordance with the manufacturer's instructions.



Caution

- Change battery only in area known to be non-hazardous.
- Use only mPower's battery PN: M004-3002-000 (12.01.09.0001).



Attention

- Changez la batterie uniquement dans une zone connue pour être non dangereuse.
- Utiliser uniquement la batterie mPower PN: M004-3002-000 (12.01.09.0001).

1



Warning

- Never operate the monitor when the cover is removed.
- Remove the monitor cover and battery only in area known as non-hazardous.
- Use only mPower's lithium battery part number M004-3002-000 (12.01.09.0001).
- This instrument has not been tested in an explosive gas/air atmosphere having oxygen concentration greater than 21%.
- Substitution of components will impair suitability for intrinsic safety and void warranty.
- It is recommended to bump test with a known concentration gas to confirm the instrument is functioning properly before use.
- Before use, ensure that the colorless ESD layer on the display is not damaged or peeling. (The blue protective film may be removed.)



Avertissement

- N'utilisez jamais le moniteur lorsque le couvercle est enlevé.
- Retirer le couvercle du moniteur et la batterie uniquement dans une zone connue comme non dangereuse.
- Utilisez uniquement le numéro de pièce de la batterie au lithium mPower M004-3002-000 (12.01.09.0001).
- Cet instrument n'a pas été testé dans une atmosphère explosive gaz / air ayant une concentration en oxygène supérieure à 21%.
- La substitution de composants compromettra l'aptitude à la sécurité intrinsèque et annulera la garantie.
- Il est recommandé de tester avec un gaz de concentration connu pour confirmer que l'instrument fonctionne correctement avant de l'utiliser.
- Avant l'utilisation, assurez-vous que la couche ESD incolore de l'écran n'est pas endommagée ou épluchée. (Le film protecteur bleu peut être enlevé.)

2

User Interface

Two key operation, four sensor sockets, one big LCD, eight alarm LEDs, one buzzer, two vibration alarms.

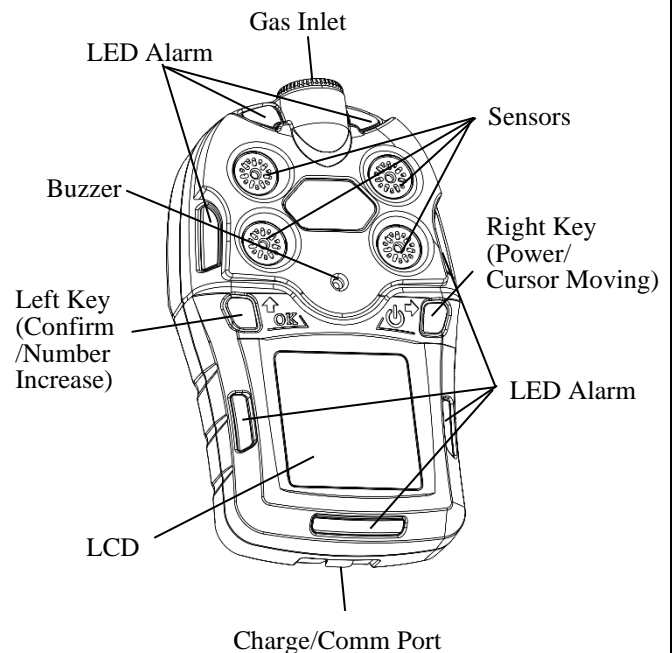

3

Turning the Unit On

Press and hold the Down Key for 3 seconds, until the buzzer beeps and the red LED flashes. After a warm up and self-test sequence, the unit enters normal reading mode, showing real time gas concentrations.

Turning the Unit Off

In normal reading mode, press and hold the Down Key for a 5-second count down, until “Unit Off” is displayed.

Charging

Always fully charge the battery before use. Plug the charger into the bottom of the POLI. The battery icon on the LCD shows the charge status. During active charging, the icon cycles from empty to full and a yellow alarm light remains on, which switches to green when completely charged.

Charging/Comm Cable

The USB Charging/Communications cable allows charging the unit on a personal computer. A locally-purchased cable can work as well for charging, but mPower’s cable must be used for proper data transfer when communicating with mPower Suite.

4

Normal Mode

After warm-up is complete, the unit enters normal reading mode and displays the instantaneous gas concentrations continuously.

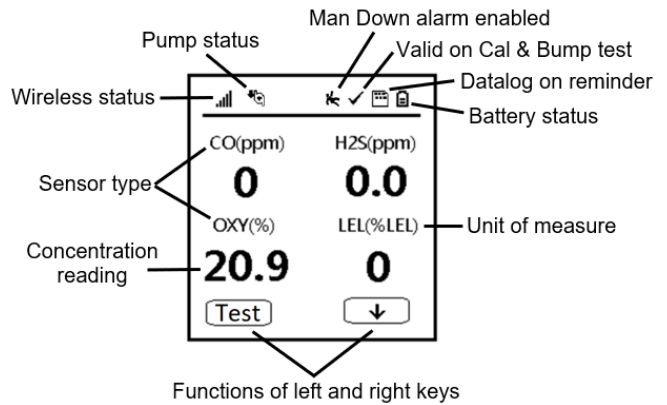

Other values like STEL, TWA, Peak, Min, Date, LEL gas, etc. can be checked by pressing the Right Key to cycle through these screens one by one. The Left “Test” key checks alarm function and last bump and calibration date.

Two text and symbol boxes at the LCD bottom are mapped to the Left [+ / OK] and Right [⏻ / ↓] keys. The text or symbol in the boxes varies with the menu.

5

Configuration Mode





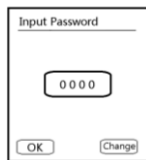

In Config Mode, the user can perform sensor calibrations, change the alarm limits and set up other parameters. To navigate, use the Left and Right key functions as indicated on the LCD bottom. In general, the Right [⏻ / ↓] moves the cursor to highlight a function and Left [+ / OK] enters or exits the function or changes numerical values.

Enter Config Mode

Hold down the Left and Right Keys together for 3 sec. The config mode is password protected with a default password of “0000”. Input all four digits and press Left (OK) to enter config mode.



Config Mode Menu



-  **Calibration:** Calibration, Bump, Set span value
-  **Measure:** Enable/Disable sensors, Gas units
-  **Alarm:** Set alarm limits, Man-Down info, etc.
-  **Datalog:** Clear data, Set interval, Select sensors
-  **Monitor Set-up:** LCD, Pump speed, Language
-  **Wireless:** Wireless on/off or Register
-  **Exit:** Exit from Config Mode

6

Exit Config Mode

Press the Right Key repeatedly until the “Exit” icon is highlighted, then press Left to exit.

Scrolling Numerical Entries

While modifying numerical values such as span values or alarm limits, the function of the Left [+ / OK] key can be switched between number increase  and decrease  by pressing both keys simultaneously.

Change Alarm Limits

All alarm limits can be customized, including High, Low, STEL and TWA alarms.

- To enter the alarm limit setting:
Config mode → Alarm Menu → Alarm Type.
- To change a value:
Press Right to highlight the desired digit and press Left to change the value. Holding down the Left Key for continuous number scrolling.
- To save and exit:
Press the Right Key until “Done “ appears in the bottom-left corner, then press Left to exit. If changes have been made, there will be a message to confirm saving the new values. Press “Yes” to save, “No” to discard.

7

Bump Test

A bump test is a quick 30-second check if the sensors and alarms functioning, without doing a precise calibration.

- To enter bump test:

Config mode → Calibration Menu → Bump Test

- Select sensors to be bump tested:

All sensors are selected by default. Press Right to start selecting, and Left to toggle a selection on or off. Move the highlight with the Right key, then press the check box when all selections are done.

- Apply test gas to the inlet.
- Press Left (Start) to initiate the 30-second bump test timer. When complete, a Pass or Fail result is displayed

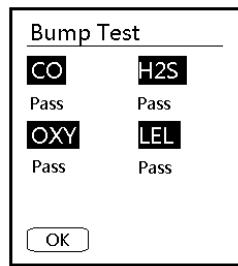
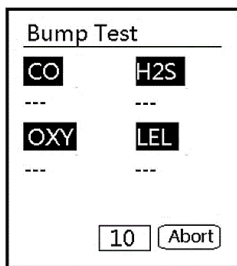
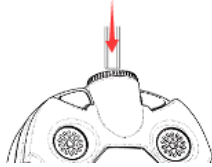

8

Fresh Air Calibration

Zero calibration sets the baseline for the sensor and is done in normal fresh air or other clean air source.

- Enter fresh air calibration:
Config Mode → Calibration → Fresh Air Calib.
- Select sensors to be zeroed in the same manner as described for Bump testing.

- Start fresh air zero:

Press the Left key and a count-down timer starts. When the count-down is finished, “Pass” or “Fail” will be displayed alternately with the reading. To abort the zero calibration use the Left key during count down.

- The Oxygen sensor is set to 20.9% during Fresh Air calibration and can be zeroed using the Single Zero menu.

9

Span Calibration

Span calibration uses known concentrations of gas to define the response of the sensor(s) to the gas(es). Multiple sensors can be calibrated simultaneously using a gas mixture. Use a fixed-flow regulator providing about 0.5 LPM. For pumped units a demand-flow regulator can also be used.

- To **Set Span Value**:

Config Mode → Calibration Menu → Span Value

- Press Right to highlight a sensor, Left to select and Left [+ / OK] again to increase or decrease that sensor’s span concentration. Repeat with other sensors as needed.

- To perform **Span Calibration**:

Config Mode → Calibration Menu → Span Calib → Select Sensor as for Bump Test → Span Calib

- Apply gas to gas inlet, on the top of the unit.
- Press Start and wait for the count-down timer and calibration result.

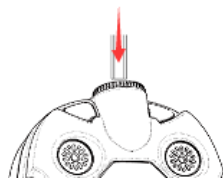

- Switch off the gas and exit Calib Mode.

10

Maintenance and Service

For pumped units, replace the inlet filter a regular basis, especially when used in high-dust environments.

For battery or sensor replacement and other maintenance or services, please contact mPower’s service department or refer to the User Manual.

11